

<b>DE</b>	Montageanleitung	<b>2</b>
<b>FR</b>	Instructions de montage	<b>2</b>
<b>EN</b>	assembly instructions	<b>3</b>
<b>IT</b>	Istruzioni per Installazione	<b>3</b>
<b>ES</b>	Instrucciones de montaje	<b>4</b>
<b>NL</b>	Handleiding	<b>4</b>
<b>DK</b>	Monteringsvejledning	<b>5</b>
<b>PT</b>	Manual de Instalação	<b>5</b>
<b>PL</b>	Instrukcja montażu	<b>6</b>
<b>CS</b>	Montážní návod	<b>6</b>
<b>SK</b>	Montážny návod	<b>7</b>
<b>ZH</b>	组装说明	<b>7</b>
<b>RU</b>	Инструкция по монтажу	<b>8</b>
<b>HU</b>	Szerelési útmutató	<b>8</b>
<b>FI</b>	Asennusohje	<b>9</b>
<b>SV</b>	Monteringsanvisning	<b>9</b>
<b>LT</b>	Montavimo instrukcijos	<b>10</b>
<b>HR</b>	Uputstva za instalaciju	<b>10</b>
<b>TR</b>	Montaj kılavuzu	<b>11</b>
<b>RO</b>	Instrucțiuni de montare	<b>11</b>
<b>EL</b>	Οδηγία συναρμολόγησης	<b>12</b>
<b>SL</b>	Navodila za montažo	<b>12</b>
<b>ET</b>	Paigaldusjuhend	<b>13</b>
<b>LV</b>	Montāžas instrukcija	<b>13</b>
<b>SR</b>	Uputstvo za montažu	<b>14</b>
<b>NO</b>	Montasjeveiledning	<b>14</b>
<b>BG</b>	Ръководство за монтаж	<b>15</b>
<b>SQ</b>	Udhëzime rreth montimit	<b>15</b>
<b>AR</b>	تعليمات التجميع	<b>16</b>

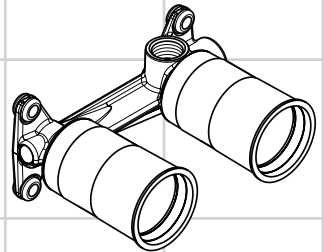

13622180



## Sicherheitshinweise

- ⚠ Bei der Montage müssen zur Vermeidung von Quetsch- und Schnittverletzungen Handschuhe getragen werden.
- ⚠ Große Druckunterschiede zwischen den Kalt- und Warmwasseranschlüssen müssen ausgeglichen werden.

## Montagehinweise

- Achtung! Die Armatur muss nach den gültigen Normen montiert, gespült und geprüft werden.
- Vor der Montage muss das Produkt auf Transportschäden untersucht werden. Nach dem Einbau werden keine Transport- oder Oberflächenschäden anerkannt.

## Symbolerklärung



Kein essigsäurehaltiges Silikon verwenden!



**Endmontage** (siehe Seite 19)



**Maße** (siehe Seite 17)



**Serviceteile** (siehe Seite 17)



**Prüfzeichen** (siehe Seite 17)

## Consignes de sécurité

- ⚠ Lors du montage, porter des gants de protection pour éviter toute blessure par écrasement ou coupure.
- ⚠ Il est conseillé d'équilibrer les pressions de l'eau chaude et froide.

## Instructions pour le montage

- Attention! La robinetterie doit être installée, rincée et contrôlée conformément aux normes valables.
- Avant son montage, s'assurer que le produit n'a subi aucun dommage pendant le transport. Après le montage, tout dommage de transport ou de surface ne pourra pas être reconnu.

## Description du symbole



Ne pas utiliser de silicone contenant de l'acide acétique!



**Finition** (voir page 19)



**Dimensions** (voir page 17)



**Pièces détachées** (voir page 17)





**Classification acoustique et débit** (voir page 17)





### Safety Notes

-  Gloves should be worn during installation to prevent crushing and cutting injuries.
-  The hot and cold supplies must be of equal pressures.

### Installation Instructions

- Important! The fitting must be installed, flushed and tested after the valid norms.
- Prior to installation, inspect the product for transport damages. After it has been installed, no transport or surface damage will be honoured.

### Symbol description



Do not use silicone containing acetic acid!



**Final assembly** (see page 19)



**Dimensions** (see page 17)





**Spare parts** (see page 17)



**Test certificate** (see page 17)

### Indicazioni sulla sicurezza

-  Durante il montaggio, per evitare ferite da schiacciamento e da taglio bisogna indossare guanti protettivi.
-  Attenzione! Compensare le differenze di pressione tra i collegamenti dell'acqua fredda e dell'acqua calda.

### Istruzioni per il montaggio

- Attenzione! La rubinetteria deve essere installata, pulita e testata secondo le istruzioni riportate!
- Prima del montaggio è necessario controllare che non ci siano stati danni durante il trasporto. Una volta eseguito il montaggio, non verranno riconosciuti eventuali danni di trasporto o delle superfici.

### Descrizione simbolo



Non utilizzare silicone contenente acido acetico!



**Montaggio finale** (vedi pagg. 19)



**Ingombri** (vedi pagg. 17)



**Parti di ricambio** (vedi pagg. 17)



**Segno di verifica** (vedi pagg. 17)

**Assembly**  
see page 18



**Montaggio**  
vedi pagg. 18



## Indicaciones de seguridad

- ⚠ Durante el montaje deben utilizarse guantes para evitar heridas por aplastamiento o corte.
- ⚠ Grandes diferencias de presión en servicio entre agua fría y agua caliente deben equilibrarse.

## Veiligheidsinstructies

- ⚠ Bij de montage moeten ter voorkoming van kneel- en snijwonden handschoenen worden gedragen.
- ⚠ Grote drukverschillen tussen de koud- en warmwatertoevoer dienen vermeden te worden.

## Indicaciones para el montaje

- ¡ATENCIÓN! El grifo tiene que ser instalado, probado y testado, según las normas en vigor.
- Antes del montaje se debe examinarse el producto contra daños de transporte. Después de la instalación se reconoce ningún daño de transporte o de superficie.

## Montage-instructies

- Attention! Leidingen doorspoelen volgens Norm. De mengkraan vervolgens monteren en controleren.
- Vóór de montage moet het product gecontroleerd worden op transportschade. Na de inbouw wordt geen transport- of oppervlakteschade meer aanvaard.

## Descripción de símbolos



No utilizar silicona que contiene ácido acético!



**Montaje final** (ver página 19)



**Dimensiones** (ver página 17)



**Repuestos** (ver página 17)



**Marca de verificación** (ver página 17)

## Symboolbeschrijving



Gebruik geen zuurhoudende siliconen!



**Afmontage** (zie blz. 19)



**Maten** (zie blz. 17)



**Service onderdelen** (zie blz. 17)





**Keurmerk** (zie blz. 17)





### Sikkerhedsanvisninger

-  Ved monteringen skal der bruges handsker for at undgå kvæstelser og snitsår.
-  Større trykforskelle mellem koldt og varmt vand bør udjævnes.

### Monteringsanvisninger

- Advarsel! Ifølge gældende regler, skal armaturet monteres, skylles igennem og afprøves.
- Før monteringen skal produktet kontrolleres for transportskader. Efter monteringen godkendes transportskader eller skader på overfladen ikke længere.

### Symbolbeskrivelse



Der må ikke benyttes eddikesyreholdig silikone!



**Slutmontering** (se s. 19)



**Målene** (se s. 17)





**Reservedele** (se s. 17)



**Godkendelse** (se s. 17)

### Avisos de segurança

-  Durante a montagem devem ser utilizadas luvas de protecção, de modo a evitar ferimentos resultantes de entalamentos e de cortes.
-  Grandes diferenças entre as pressões das águas quente e fria devem ser compensadas.

### Avisos de montagem

- Atenção! A misturadora deve ser instalada, purgada e testada de acordo com as normas em vigor.
- Antes da montagem deve-se controlar o produto relativamente a danos de transporte. Após a montagem não são aceites quaisquer danos de transporte ou de superfície.

### Descrição do símbolo



Não utilizar silicone que contenha ácido acético!



**Acabamento Fina** (ver página 19)



**Medidas** (ver página 17)



**Peças de substituição** (ver página 17)





**Marca de controlo** (ver página 17)





## Wskazówki bezpieczeństwa

-  Aby uniknąć zranień, takich jak zgniecenia czy przecięcia, podczas montażu należy nosić rękawice.
-  Znaczne różnice ciśnień na dopływach ciepłej i zimnej wody muszą zostać wyrównane.

## Wskazówki montażowe

- Uwaga! Armatura musi być zamontowana, przepłukana i wypróbowana według obowiązujących norm.
- Przed montażem należy skontrolować produkt pod kątem szkód transportowych. Po montażu nie widać żadnych szkód transportowych ani szkód na powierzchni.

## Opis symbolu



Nie stosować silikonów zawierających kwas octowy!



**Montaż końcowy** (patrz strona 19)



**Wymiary** (patrz strona 17)





**Części serwisowe** (patrz strona 17)



**Znak jakości** (patrz strona 17)

## Bezpečnostní pokyny

-  Pro zabránění řezným zraněním a pohmožděním je nutné při montáži nosit rukavice.
-  Je nutné vyrovnat velké rozdíly tlaku mezi přípoji studené a teplé vody.

## Pokyny k montáži

- Pozor! Armatura se musí montovat, proplachovat a testovat podle platných norem.
- Před montáží je třeba produkt zkontrolovat, zda nebyl při transportu poškozen. Po zabudování nebudou uznány žádné škody způsobené transportem nebo poškození povrchu.

## Popis symbolů



Nepoužívat silikon s obsahem kyseliny octové!



**Konečná montáž** (viz strona 19)



**Rozměry** (viz strona 17)



**Servisní díly** (viz strona 17)



**Zkušební značka** (viz strona 17)





## Bezpečnostné pokyny

- △ Pri montáži musíte nosiť rukavice, aby ste predišli pomliaždeninám a rezným poraneniam.
- △ Velké rozdiely v tlaku medzi prípojkami studenej a teplej vody musia byť vyrovnané.

## Pokyny pre montáž

- Pozor! Armatúra sa musí montovať, preplachovať a testovať podľa platných noriem.
- Pred montážou musíte produkt skontrolovať, či nebol počas transportu poškodený. Po zabudovaní nebudú uznané žiadne škody spôsobené transportom alebo poškodenia povrchu.

## Popis symbolov



Nepoužívať silikón s obsahom kyseliny octovej!



**Konečná montáž** (viď strana 19)



**Rozmery** (viď strana 17)



**Servisné diely** (viď strana 17)



**Osvedčenie o skúške** (viď strana 17)

## 安全技巧

- △ 装配时为避免挤压和切割受伤，必须戴上手套。
- △ 冷热水管间过大的压力差必须予以平衡。

## 安装提示

- 注意！必须按照现行的规定安装，冲洗和测试产品。
- 安装前必须检查产品是否受到运输损害。安装后将不认可运输损害或表面损伤。

## 符号说明



请勿使用含有乙酸的硅！



**总装配** (参见第 19 页)



**大小** (参见第 17 页)



**备用零件** (参见第 17 页)



**检验标记** (参见第 17 页)





## Указания по технике

### Безопасности

- △ Во время монтажа следует надеть перчатки во избежание прищемления и порезов.
- △ донного клапа. Перед установкой смесителя необходимо регулировочными кранами выровнять авление холодной и горячей воды при помощи вентмлей регулирующих подачу воды в квартиру.

## Указания по монтажу

- Внимание! Смеситель должен быть смонтирован по действующим нормам и в соответствии с настоящей инструкцией, проверен на геметичность и безупречность работы.
- Перед монтажом следует проверить изделие на предмет повреждений при перевозке. После монтажа претензии о возмещении ущерба за повреждения при перевозке или повреждения поверхностей не принимаются.

## Описание символов



Не применяйте силикон, содержащий уксусную кислоту.



**Окончательная сборка** (см. стр. 19)



**Размеры** (см. стр. 17)



**Комплект** (см. стр. 17)



**Знак технического контроля** (см. стр. 17)



## Biztonsági utasítások

- △ A szerelésnél a zúzódások és vágási sérülések elkerülése érdekében kesztyűt kell viselni.
- △ A hidegvíz- és a melegvíz-csatlakozások közötti nagy nyomáskülönbséget kikell egyenlíteni!

## Szerelési utasítások

- Figyelem! A csaptelepet az érvényben lévő előírásoknak megfelelően kell felszerelni, átöblíteni és ellenőrizni.
- A szerelés előtt ellenőrizni kell, hogy a terméknek nincs-e szállítási sérülése. Beépítés után a szállítási- vagy felületi sérüléseket nem ismerik el.

## Szimbólumok leírása



Ne használjon ecetsavtartalmú szilikont!



**Beépített, kész szerelvény** (lásd a 19. oldalon)



**Méretet** (lásd a 17. oldalon)



**Tartozékok** (lásd a 17. oldalon)



**Vizsgajel** (lásd a 17. oldalon)







## Turvallisuusohjeet

- △ Asennuksessa on käytettävä käsineitä puristumien ja viiltojen aiheuttamien tapaturmien estämiseksi.
- △ Suuret paine-erot kylmä- ja kuumavesiliitäntöjen välillä on tasattava.

## Asennusohjeet

- Huomio! Kaluste on asennettava, huuhdeltava ja tarkastettava voimassa olevien määräysten mukaisesti.
- Ennen asennusta on tarkastettava tuotteen mahdolliset kuljetusvahingot. Asennuksen jälkeen kuljetus- ja pintavaurioita ei hyväksytä.

## Merkin kuvaus



Älä käytä etikahappopitoista silikonial



**Loppuasennus** (katso sivu 19)



**Mitat** (katso sivu 17)



**Varaosat** (katso sivu 17)



**Koestusmerkki** (katso sivu 17)

## Säkerhetsanvisningar

- △ Handskar ska bäras under monteringsarbetet så att man kan undvika kläm- och skärskadorgen werden.
- △ Stora tryckskillnader mellan anslutningarna för varmt och kallt vatten måste utjämnas.

## Monteringsanvisningar

- OBS! Armaturen måste installeras, genomspolas och testas enligt gällande föreskrifter.
- Det måste undersökas om produkten har transportskador innan den monteras. Efter monteringen accepteras inga transport- eller ytskitkskador.

## Symbolförklaring



Använd inte silikon som innehåller ättiksyra!



**Slutmontering** (se sidan 19)



**Måtten** (se sidan 17)



**Reservdelar** (se sidan 17)



**Testsigill** (se sidan 17)





## Saugumo technikos nurodymai

- ⚠ Apsaugai nuo užspaudimo ir įsijovimo montavimo metu mėvėkite pirštines.
- ⚠ Turi būti išlyginti šalto ir karšto slėgio nelygumai.

## Sigurnosne upute

- ⚠ Prilikom montaže se radi sprječavanja prignječnja i posjekotina moraju nositi rukavice.
- ⚠ Velika razlika u pritisku između vruće i hladne vode mora biti izbalansirana.

## Montavimo instrukcija

- Dėmesio! Maišytuvus privalo būti montuojamas ir išbandomas pagal veikiančias normas ir šią instrukciją.
- Prieš montuojant būtina patikrinti, ar gaminyje nebuvo pažeistas transportavimo metu. Sumontavus pretenzijos dėl transportavimo ir paviršiaus pažeidimų nepriimamos.

## Upute za montažu

- Pažnja! Cijevi moraju biti postavljene, isprane i testirane prema važećim normama.
- Prije montaže mora se provjeriti je li proizvod oštećen prilikom transporta. Nakon ugradnje se ne priznaju nikakve reklamacije koje se odnose na površinska i transportna oštećenja.

## Simbolio aprašymas



Nenaudokite silikono, kurio sudėtyje yra acto rūgšties!



**Galutinis montavimas** (žr. psl. 19)



**Išmatavimai** (žr. psl. 17)



**Atsarginės dalys** (žr. psl. 17)



**Bandymo pažyma** (žr. psl. 17)

## Opis simbola



Nemojte koristiti silikon koji sadrži octenu kiselinu!



**Završna montaža** (pogledaj stranicu 19)



**Mjere** (pogledaj stranicu 17)



**Rezervni djelovi** (pogledaj stranicu 17)



**Oznaka testiranja** (pogledaj stranicu 17)





### ! Güvenlik uyarıları

- ! Montaj esnasında ezilme ve kesilme gibi yaralanmaları önlemek için eldiven kullanılmalıdır.
- ! Sıcak ve soğuk su bağlantıları arasında büyük basınç farklılıkları varsa, bu basınç farklılıklarının dengelenmesi gerekir.

### Montaj açıklamaları

- Önemli! Batarya monte edilmeli, geçerli normlardan sonra akis testi yapılmalıdır.
- Montaj işleminden önce ürün nakliye hasarları yönünden kontrol edilmelidir. Montaj işleminden sonra nakliye veya yüzey hasarları için sorumluluk üstlenilmemektedir.

### Simge açıklaması



Asetik asit içeren silikon kullanmayın!



**Son Uygulama** (Bakınız sayfa 19)



**Ölçüleri** (Bakınız sayfa 17)



**Yedek Parçalar** (Bakınız sayfa 17)



**Kontrol işareti** (Bakınız sayfa 17)

### ! Instrucțiuni de siguranță

- ! La montare utilizați mânăși pentru evitarea contuziunilor și tăierii mâinilor.
- ! Diferențele de presiune mari între alimentarea cu apă rece și apă caldă trebuie echilibrate.

### Instrucțiuni de montare

- Atenție! Bateria trebuie montată, clătită și verificată conform normelor în vigoare.
- Înainte de instalare verificați, dacă produsul prezintă deteriorări de transport. După instalare garanția nu acoperă deteriorările de transport și cele de suprafață.

### Descrierea simbolurilor



Nu utilizați silicon cu conținut de acid acetic!



**Montare finală** (vezi pag. 19)



**Dimensiuni** (vezi pag. 17)



**Piese de schimb** (vezi pag. 17)



**Certificat de testare** (vezi pag. 17)





## Υποδειξεις ασφαλείας

- ⚠ Για να αποφύγετε τραυματισμούς κατά τη συναρμολόγηση πρέπει να φοράτε γάντια.
- ⚠ Οι διαφορές της πίεσης μεταξύ της σύνδεσης κρύου και ζεστού νερού θα πρέπει να αντισταθμίζονται.

## Varnostna opozorila

- ⚠ Pri montaži je treba nositi rokavice, da se preprečijo poškodbe zaradi zmečkanja ali urezov.
- ⚠ Velike razlike v tlaku med priključkom za mrzlo in priključkom za toplo vodo je potrebno izravnati.

## Οδηγίες συναρμολόγησης

- Προσοχή! Η μπαταρία πρέπει να τοποθετηθεί, να πλυθεί και να ελεγχθεί με βάση τους ισχύοντες κανόνες υδραυλικής τέχνης
- Πριν τη συναρμολόγηση πρέπει να εξεταστεί το προϊόν για ζημιές μεταφοράς. Μετά την εγκατάσταση δεν αναγνωρίζονται ζημιές από τη μεταφορά ή επιφανειακές ζημιές.

## Navodila za montažo

- Attention! La robinetterie doit être installée, rincée et contrôlée conformément aux normes valables.
- Pred montažo je treba izdelek preveriti glede morebitnih transportnih poškodb. Po vgradnji transportne ali površinske poškodbe ne bodo več priznane.

## Περιγραφή συμβόλων



Μην χρησιμοποιείτε σιλικόνη που περιέχει οξικό οξύ!



**Τελική συναρμολόγηση** (βλ. σελίδα 19)



**Διαστάσεις** (βλ. σελίδα 17)



**Ανταλλακτικά** (βλ. σελίδα 17)



**Σήμα ελέγχου** (βλ. σελίδα 17)



Ne smete uporabiti silikona, ki vsebuje ocetno kislino!



**Κονčna montaža** (glejte stran 19)



**Mere** (glejte stran 17)



**Rezervni deli** (glejte stran 17)



**Preskusni znak** (glejte stran 17)



**Συναρμολόγηση**  
**βλ. σελίδα 18**



**Montaža**  
**Glejte stran 18.**



## Ohutusjuhised

-  Kandke paigaldamisel muljumis- ja löikevigastuste vältimiseks kindaid.
-  Kui külma ja kuuma vee ühenduste surve on väga erinev, tuleb need tasakaalustada.

## Paigaldamisjuhised

- Tähelepanu! Seadmestiku paigaldamine, läbipesu ja kontrollimine peab toimuma vastavalt kehtivatele normidele.
- Enne paigaldamist tuleb toodet kontrollida transpordikahjustuste osas. Pärast paigaldamist ei tunnustata enam transpordi- või pinnakahjustuste kaebuseid.

## Sümbolite kirjeldus



Ärge kasutage äädikhapet sisaldavat silikooni!



**Lõplik paigaldus** (vt lk 19)



**Mõõtude** (vt lk 17)





**Varuosad** (vt lk 17)



**Kontrollsertifikaat** (vt lk 17)

## Drošības norādes

-  Montāžas laikā, lai izvairītos no saspiedumiem un iegriezumiem, nepieciešams nēsāt cimdus.
-  Jāizlīdzina spiediena atšķirības starp aukstā un karstā ūdens pievadiem.

## Norādījumi montāžai

- Uzmanību! Jaucējkrāns jāmontē, jāskalo un jāpārbauda atbilstoši spēkā esošajām normām.
- Pirms montāžas nepieciešams pārbaudīt, vai produktam transportēšanas laikā nav radušies bojājumi. Pēc iebūvēšanas bojājumi, kas radušies transportēšanas laikā, vai virsmas bojājumi netiek atzīti.

## Simbolu nozīme



Neizmantot silikonu, kas satur etiķskābi!



**Beigu montāža** (skat. 19. lpp.)



**Izmērus** (skat. 17. lpp.)



**Rezerves daļas** (skat. 17. lpp.)



**Pārbaudes zīme** (skat. 17. lpp.)





## Sigurnosne napomene

- ⚠ Prilikom montaže se radi sprečavanja prignječenja i posekotina moraju nositi rukavice.
- ⚠ Velika razlika u pritisku između vruće i hladne vode mora biti izbalansirana.



## Sikkerhetshenvisninger

- ⚠ Bruk hansker under montasjen for å unngå klem- og kuttskader.
- ⚠ Store trykkdifferanser mellom kaldt- og varmtvannstilkoblinger skal utlignes.

## Instrukcije za montažu

- Pažnja! Armatura mora biti postavljena, isprana i testirana prema važećim normama.
- Pre montaže se mora proveriti da li je proizvod oštećen pri transportu. Nakon ugradnje se ne priznaju nikakve reklamacije koje se odnose na površinska i transportna oštećenja.

## Montagehenvisninger

- Obs! Armaturen skal monteres, spyles og sjekkes iht. gyldige standarder.
- Før montasjen skal produktet sjekkes for transportskader. Etter monteringen aksepteres ikke noen transport- eller overflateskader.

## Opis simbola



Nemojte koristiti silikon koji sadrži sirćetnu kiselinu!



**Završna montaža** (vidi stranu 19)



**Mere** (vidi stranu 17)



**Rezervni delovi** (vidi stranu 17)



**Ispitni znak** (vidi stranu 17)

## Symbolbeskrivelse



Ikke bruk silikon som inneholder eddiksyre!



**Sluttmontasje** (se side 19)



**Mål** (se side 17)



**Service deler** (se side 17)



**Prøvemerket** (se side 17)





## Указания за безопасност

- △ При монтажа трябва да се носят ръкавици, за да се избегнат наранявания поради притискане или порязване.
- △ Големите разлики в налягането между изводите за студената и топлата вода трябва да се изравняват.

## Указания за монтаж

- Внимание! Арматурата трябва да се монтира, промие и провери в съответствие с валидните норми.
- Преди монтажа продуктът трябва да се провери за транспортни щети. След монтажа не се признават транспортни или повърхностни щети.

## Описание на символите



Не използвайте силикон, съдържащ оцетна киселина!



**Довършителен монтаж** (вижте стр. 19)



**Размери** (вижте стр. 17)



**Сервизни части** (вижте стр. 17)



**Контролен знак** (вижте стр. 17)

## Udhëzime sigurie

- △ Për të evituar lëndimet e pickimeve ose të prerjeve gjatë procesit të montimit duhet që të vishni doreza.
- △ Ndryshimet e mëdha të presionit mes lidhjeve të ujit të ftohtë dhe atij të ngrohtë duhen ekuilibruar.

## Udhëzime për montimin

- Kujdes! Armatura duhet montuar, shpërlarë dhe kontrolluar në bazë të normave të vlefshme.
- Përpara montimit duhet që produkti të kontrollohet për dëmtime nga transporti. Pas instalimit nuk do të njihet asnjë dëmtim nga transporti ose dëmtim i sipërfaqes.

## Përshkrimi i simbolit



Mos përdorni silikon që në përbërje ka acid acetik.



**Montimi përfundimtar** (shih faqen 19)



**Përmasat** (shih faqen 17)



**Pjesët e servisit** (shih faqen 17)



**Shenja e kontrollit** (shih faqen 17)





## ⚠️ تنبيهات الأمان

- ⚠️ يجب إرتداء قفازات لليد أثناء التركيب لتجنب حدوث أخطار الإنحشار أو الجروح.
- ⚠️ يجب أن يكون تيار الماء الساخن والماء البارد متعادلين في الضغط.

## تعليمات التركيب

- هام! يجب تركيب الوصلة واستخدامها واختبارها وفقاً للمعايير المعمول بها.
- قبل القيام بعملية التركيب، يجب فحص المنتج للتأكد من خلوه من أية تلفيات ناتجة عن النقل. بعد القيام بعملية التركيب، لن يتم الاعتراف بوجود أية تلفيات سطحية أو تلفيات ناتجة عن عملية النقل.

## وصف الرمز

هام! لا تستخدم السليكون الذي يحتوي على أممض!



التجميع النهائي (راجع صفحة 19)



أبعاد (راجع صفحة 17)

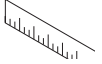

قطع الغيار (راجع صفحة 17)

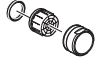



شهادة اختبار (راجع صفحة 17)



التركيب راجع صفحة 18

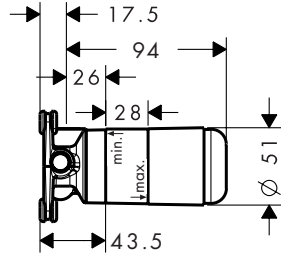
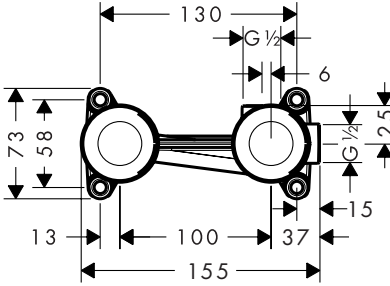
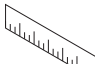



	P-IX	ACS	WRAS	ETA	 GODKENDT TIL DRILLEKAVD
<b>13622180</b>		X	X	 1.42/19221	04/00001

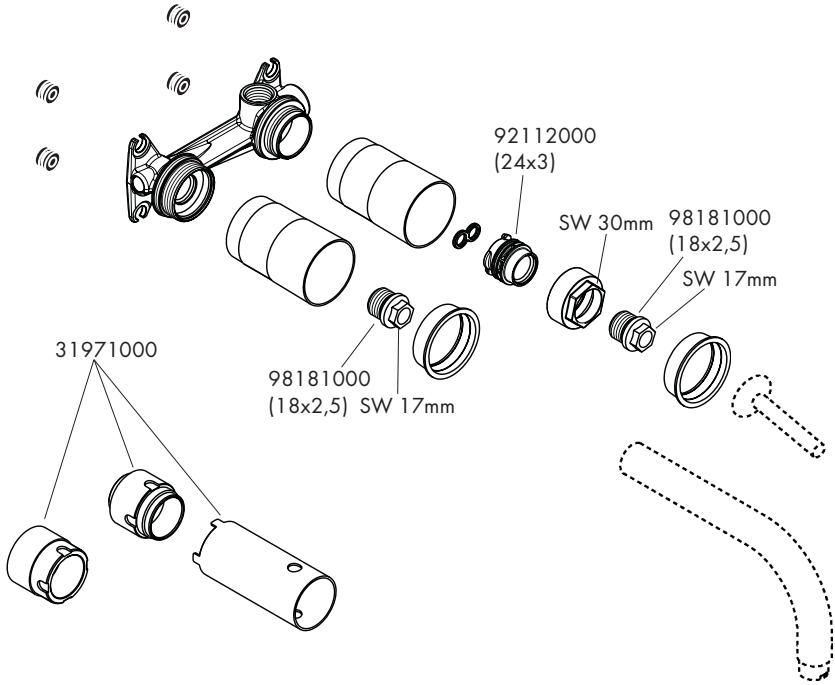

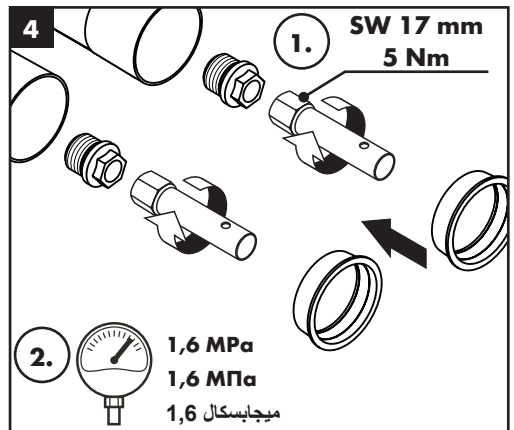
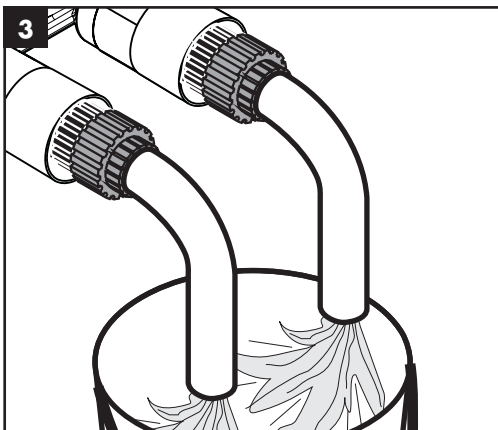
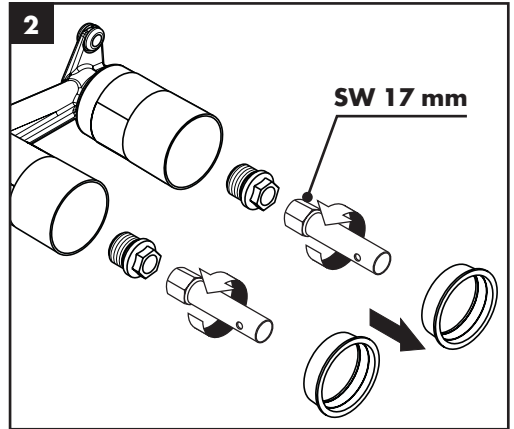
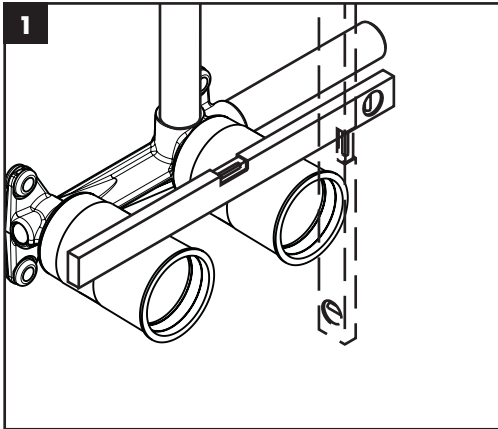
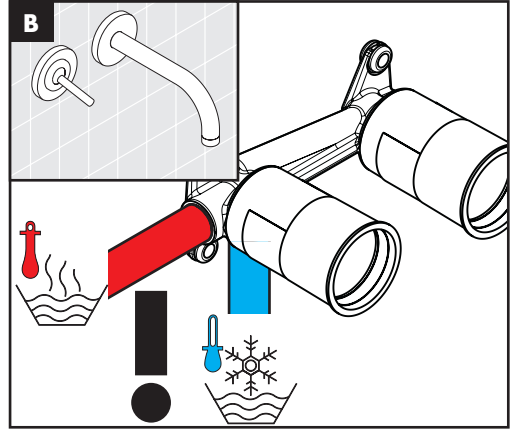
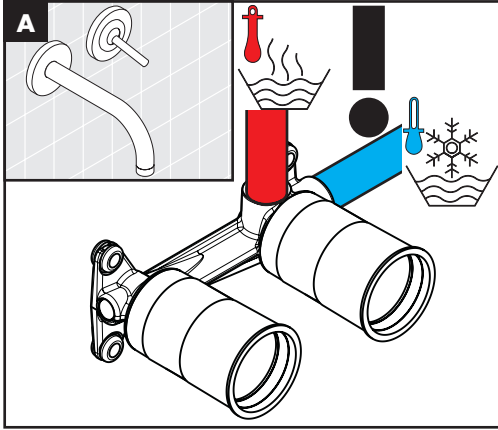



**PuraVida** 15084XXX / 15085XXX

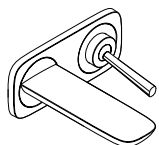

20

**Metris** 31085000 / 31251000 /  
31086000

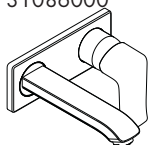

21

**Metris Classic** 31000XXX /  
31003XXX

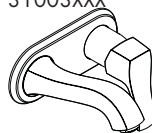

22

**Metris S** 31162000 / 31163000

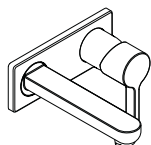

23

**Talis** 31618000 / 31620000 /  
31611000

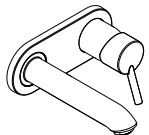

24

**Logis** 71220000

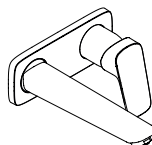

25

**Talis E** 71732000 / 71734000

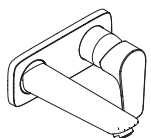

26

**Talis S** 72110000 / 72111000

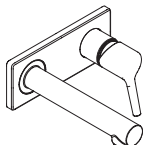

27

**Bouroullec** 19125000 /  
19127000

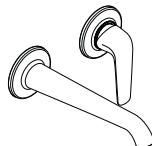

28

**Steel** 35113800 / 35116800

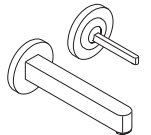

29

**Citterio M** 34112000 / 34115000

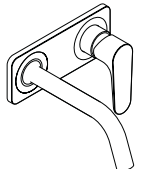

30

**Citterio M** 34113000 / 34116000

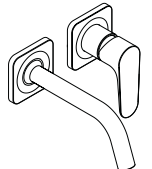

31

**Uno** 38112XXX / 38115XXX

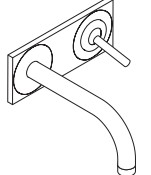

32

**Uno** 38113XXX / 38116XXX

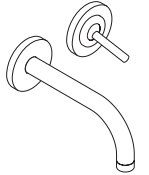

33

**Citterio** 39112XXX / 39115XXX

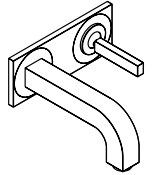

34

**Citterio** 39113XXX / 39116XXX

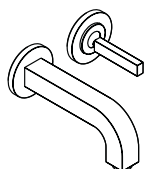

35

**Citterio E** 36106000

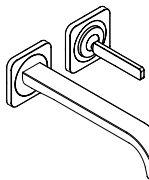

36

**Citterio E** 36114000

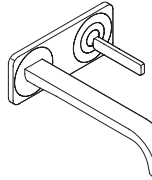

37

**Uno** 38815XXX

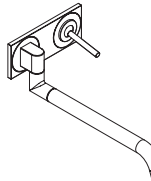

38



**PuraVida 15084XXX**

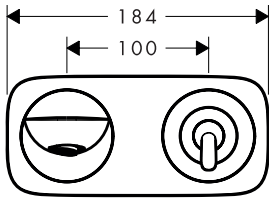
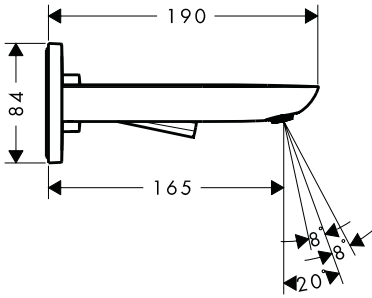

**PuraVida 15085XXX**

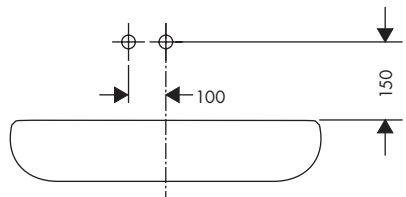
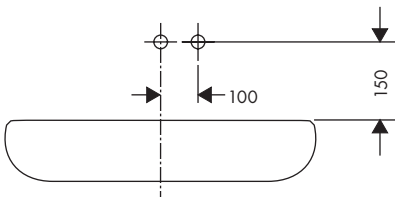
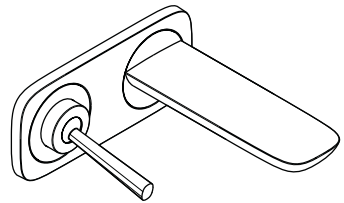
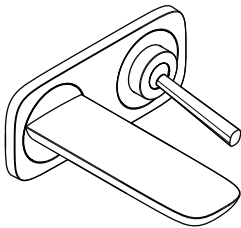
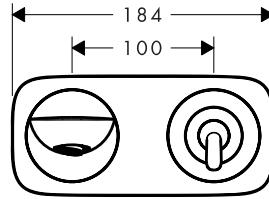
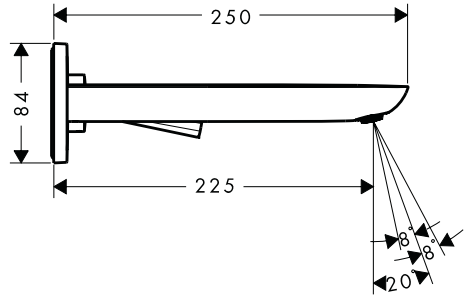



**Metris 31085000 / 31251000**

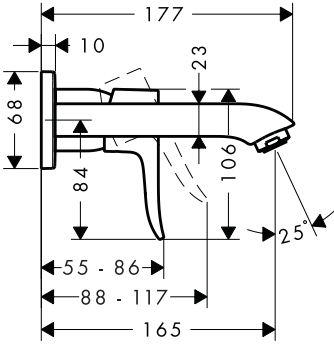

**Metris 31086000**

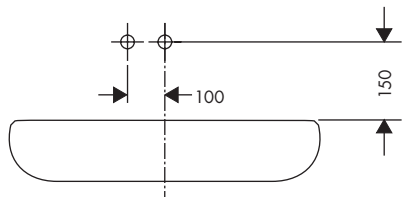
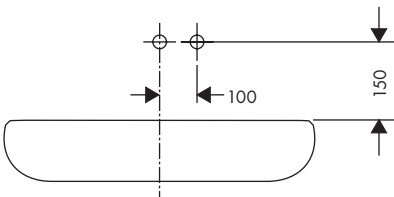
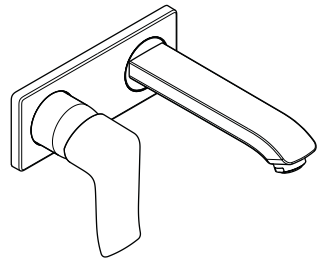
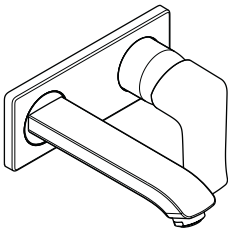
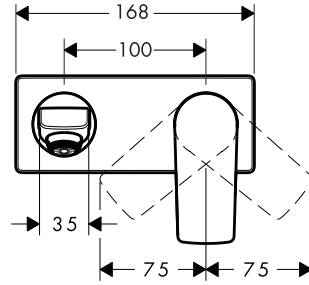
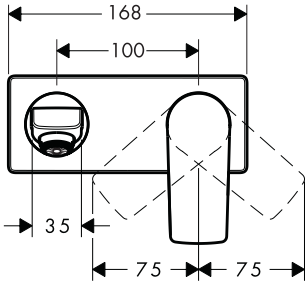
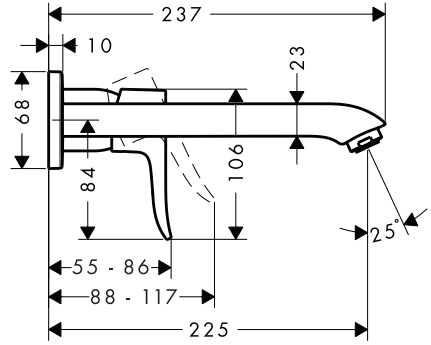



**Metris Classic 31000XXX**

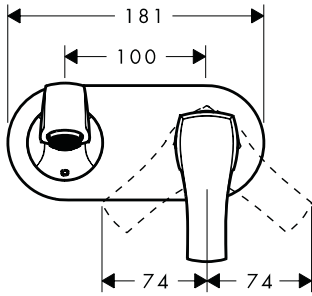
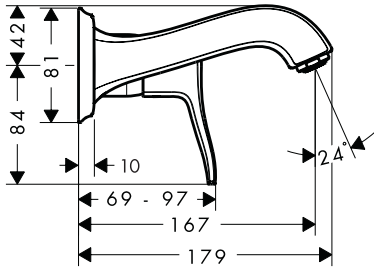

**Metris Classic 31003XXX**

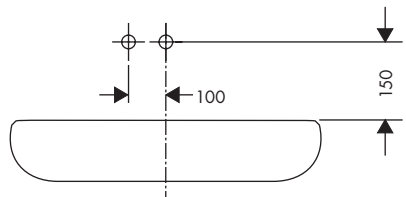
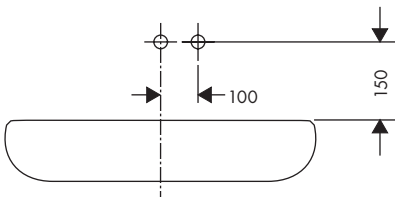
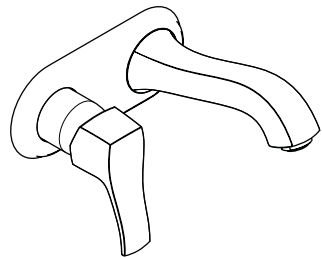
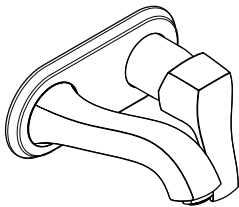
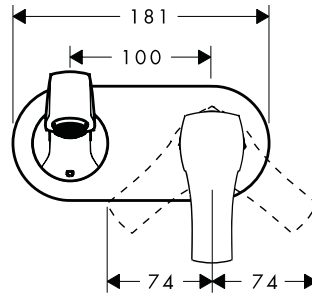
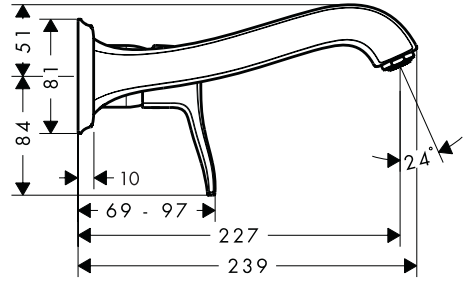



**Metris S 31162000**

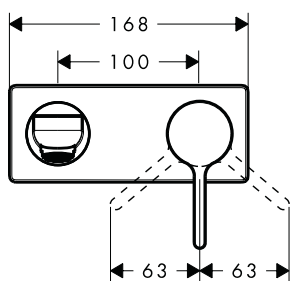
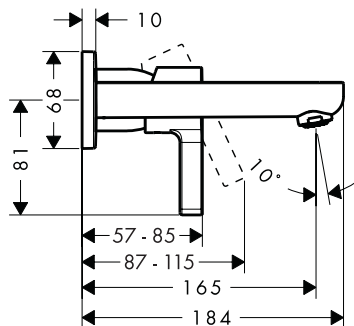

**Metris S 31163000**

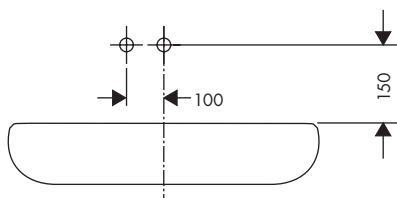
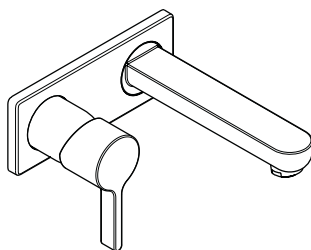
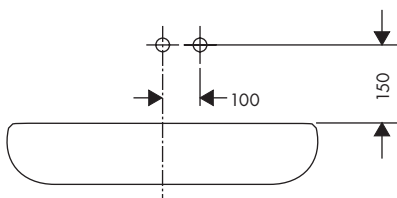
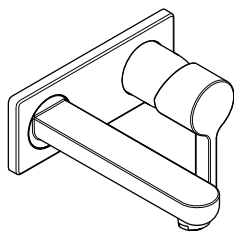
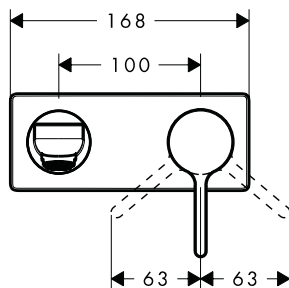
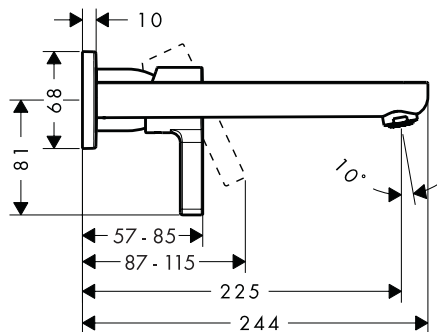



Talis 31618000 / 31620000

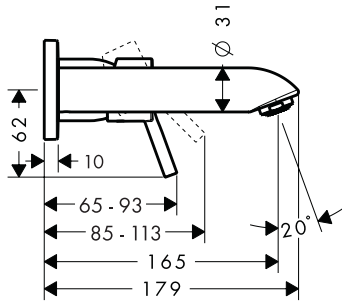

Talis 31611000

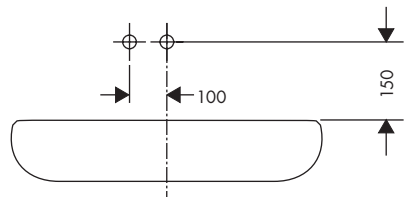
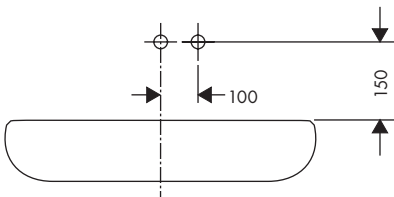
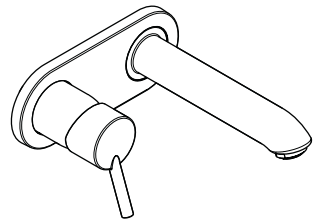
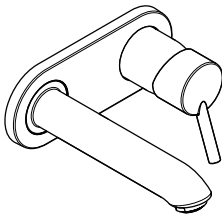
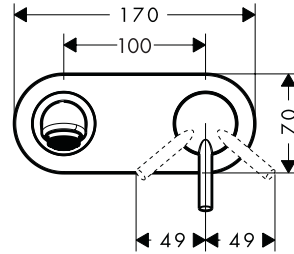
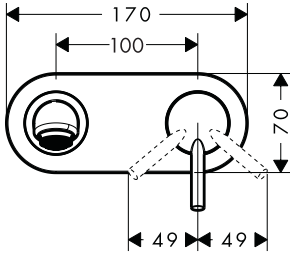
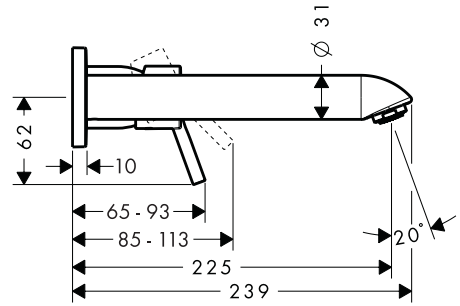





Logis 71220000

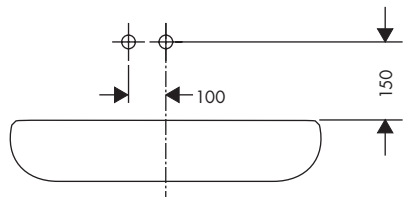
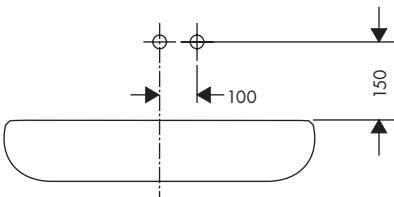
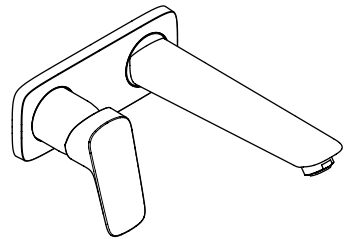
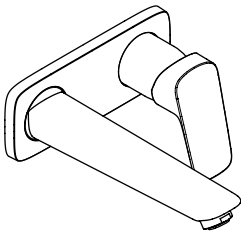
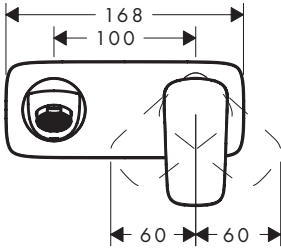
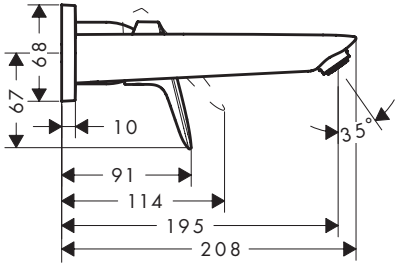



Talis E 71732000

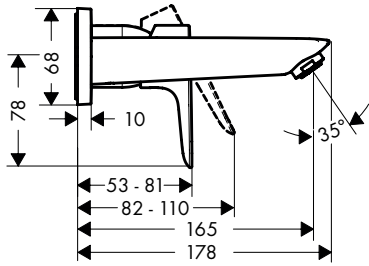

Talis E 71734000

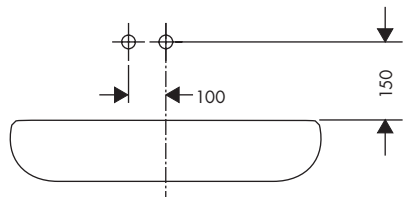
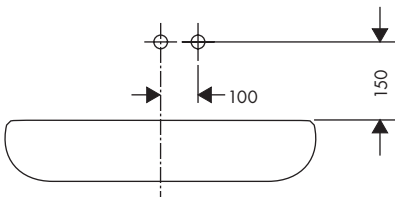
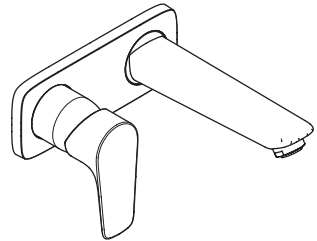
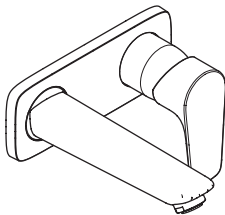
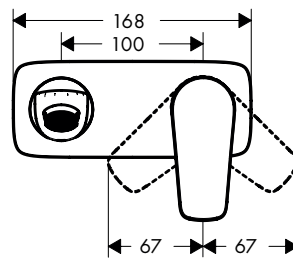
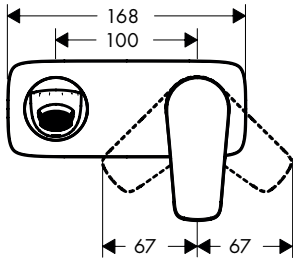
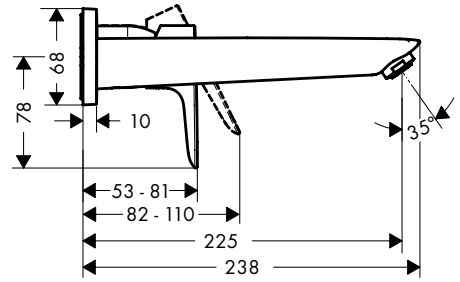



**Talis S 72110000**

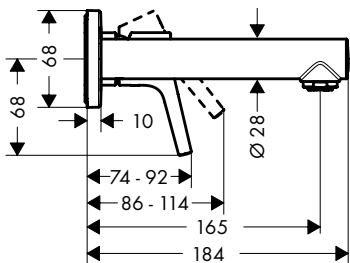

**Talis S 72111000**

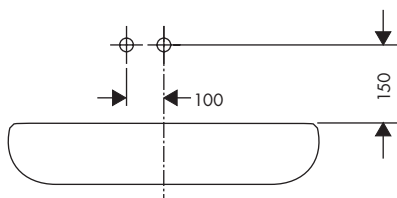
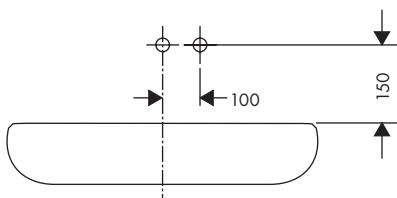
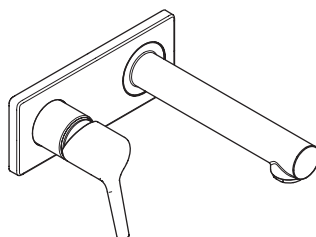
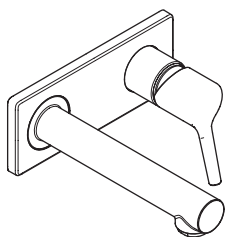
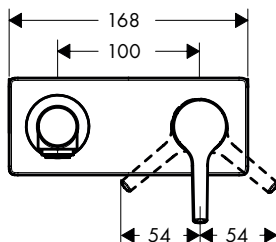
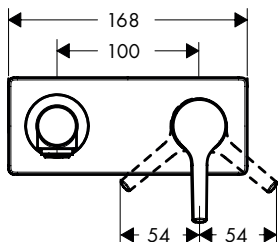
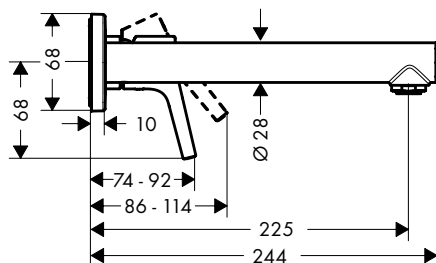



**Bouroullec 19125000**

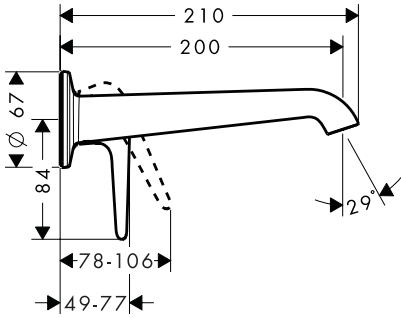

**Bouroullec 19127000**

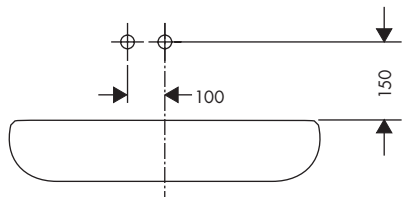
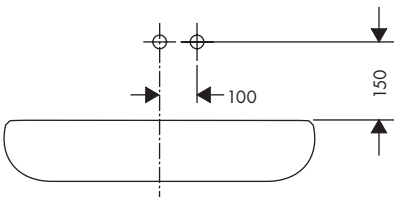
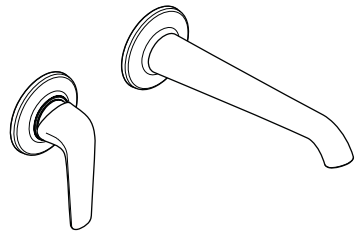
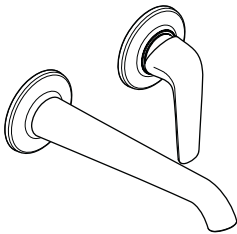
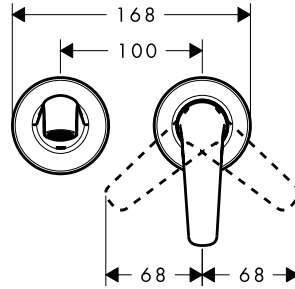
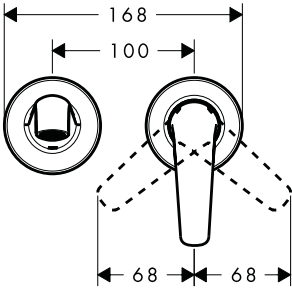
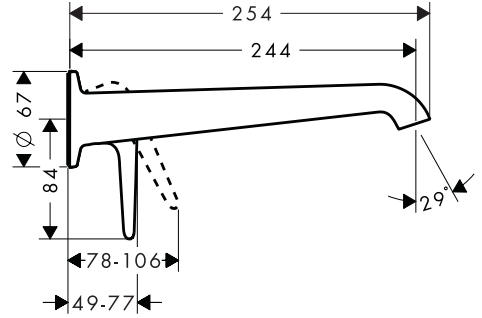



**Steel 35113800**

**Steel 35116800**

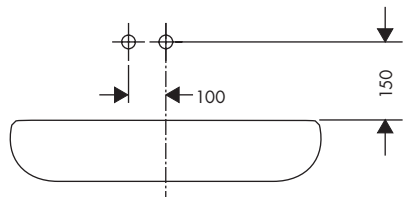
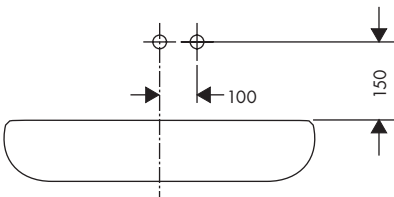
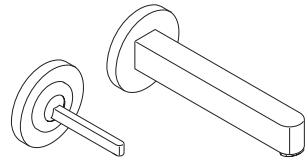
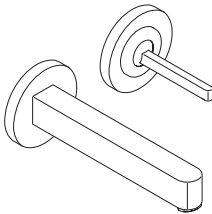
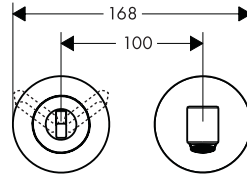
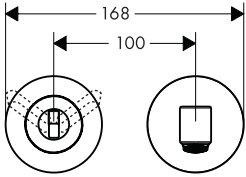
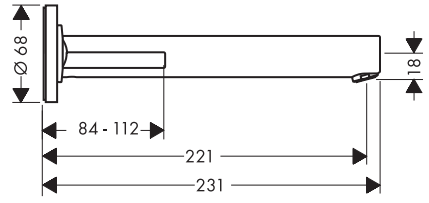
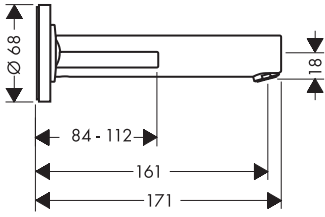



**Citterio M 34112000**

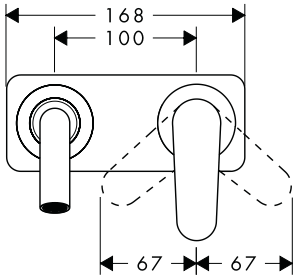
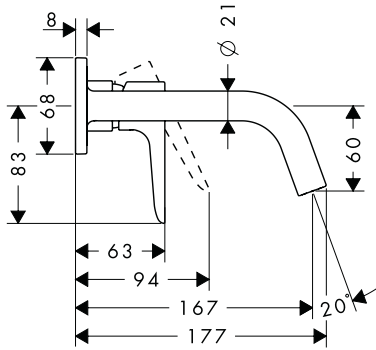

**Citterio M 34115000**

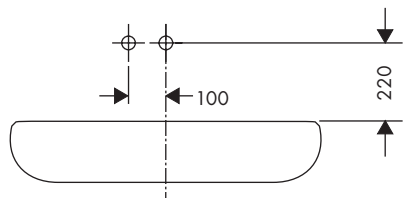
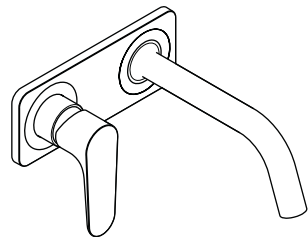
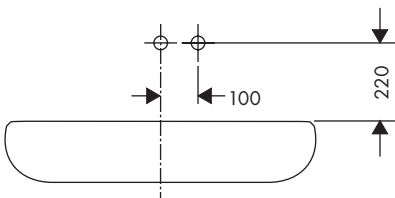
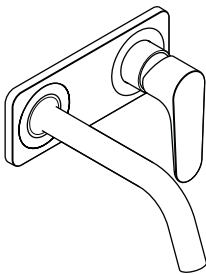
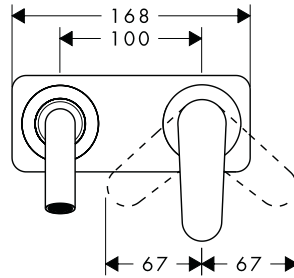
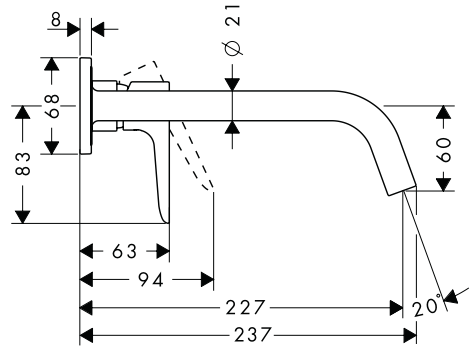



**Citterio M 34113000**

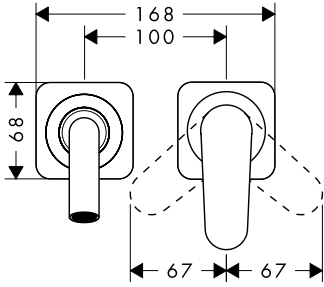
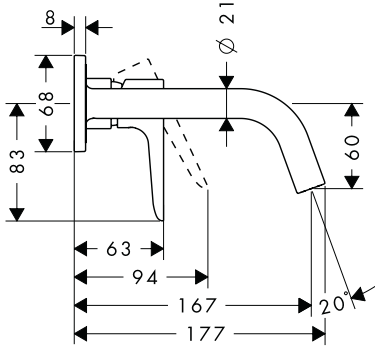

**Citterio M 34116000**

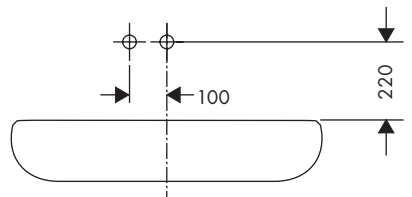
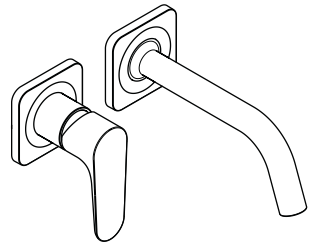
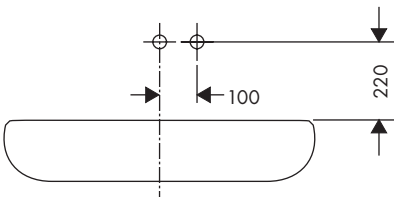
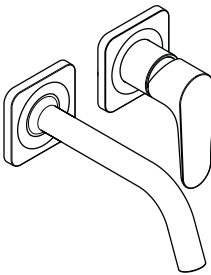
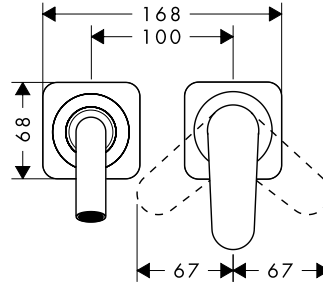
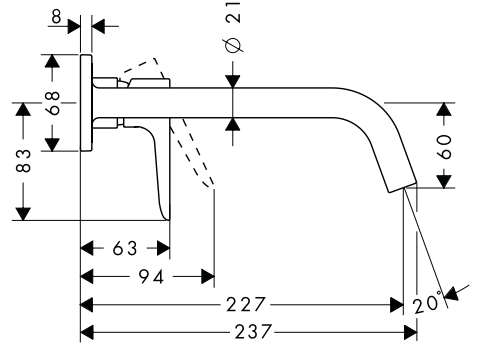



Uno 38112XXX

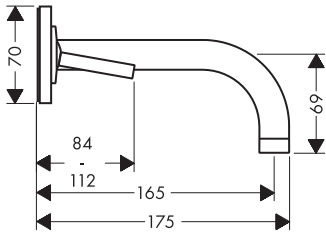

Uno 38115XXX

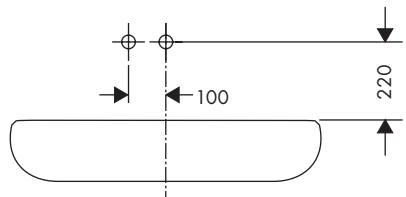
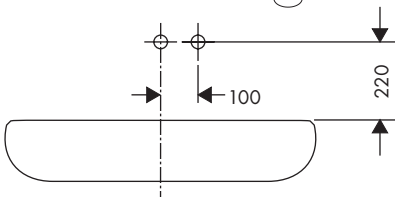
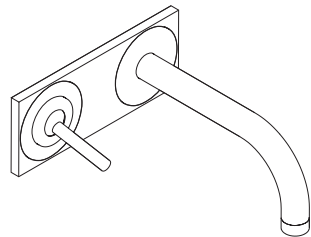
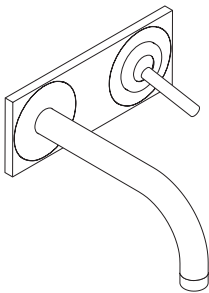
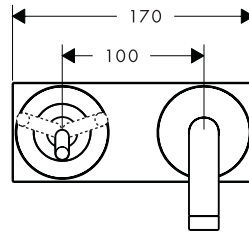
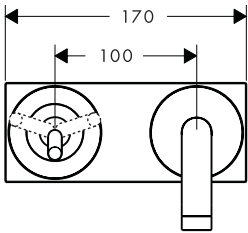
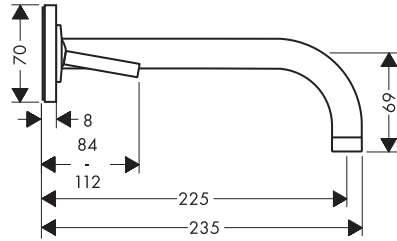





Uno 38113XXX

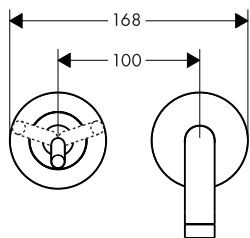
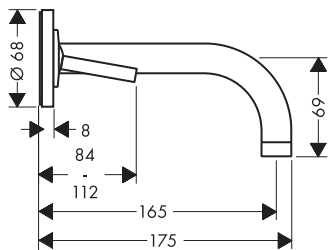

Uno 38116XXX

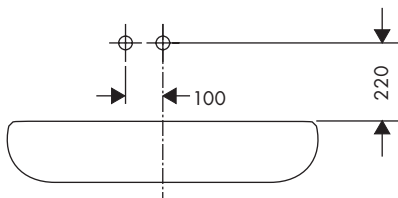
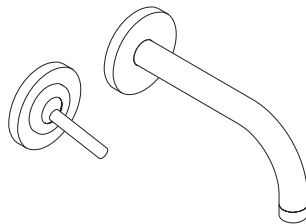
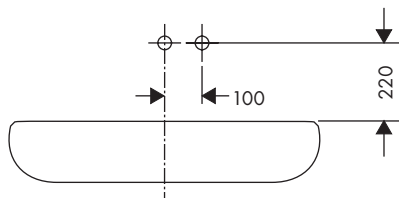
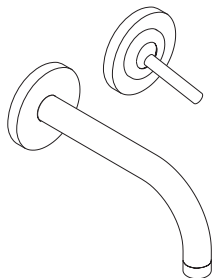
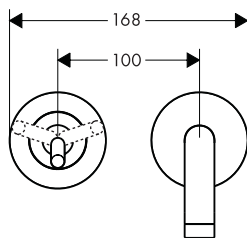
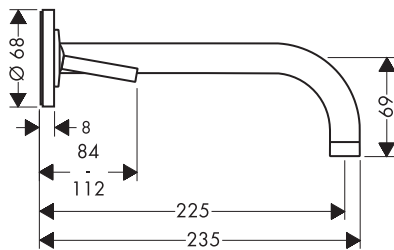



Citterio 39112XXX

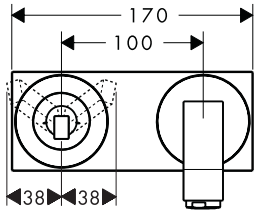
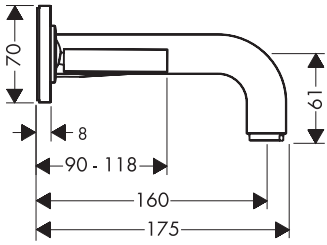

Citterio 39115XXX

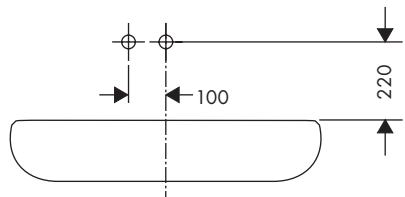
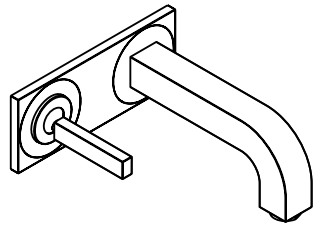
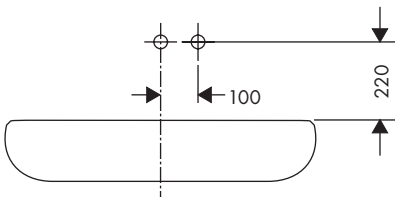
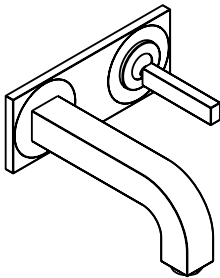
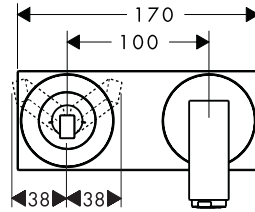
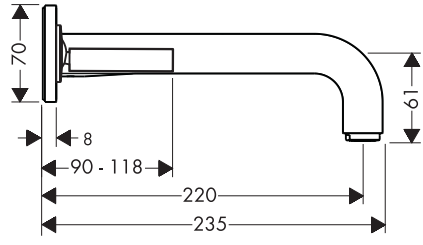



**Citterio 39113XXX**

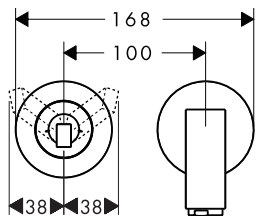
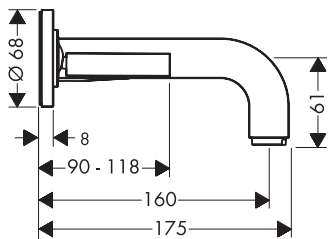

**Citterio 39116XXX**

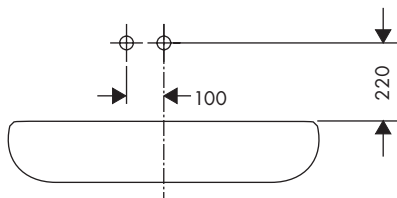
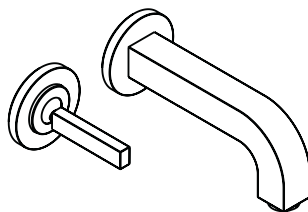
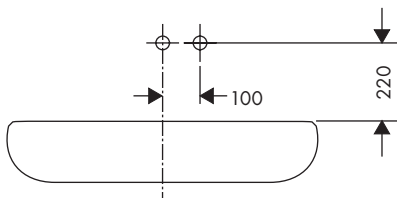
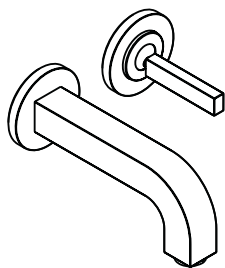
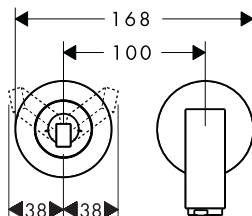
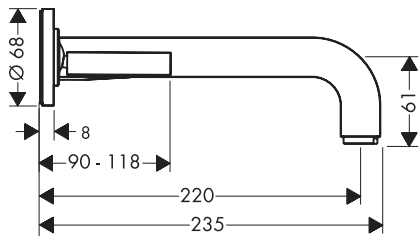



**Criterio E 36106000**

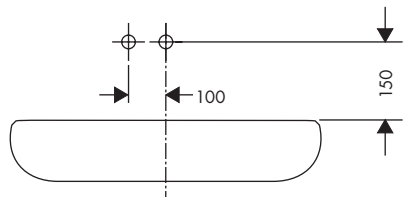
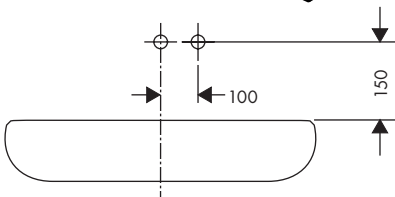
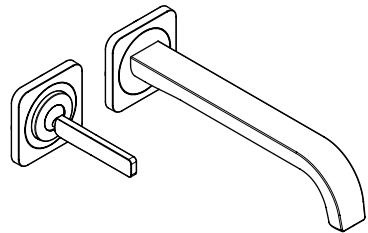
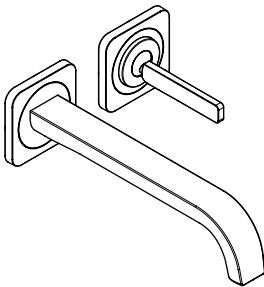
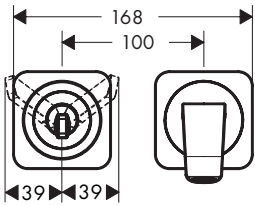
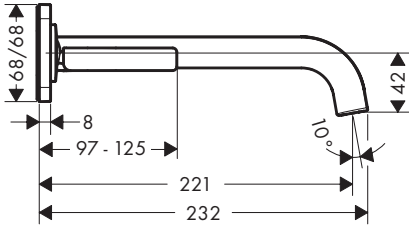



**Citterio E 36114000**

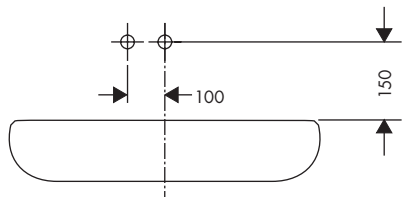
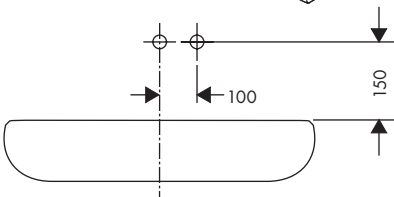
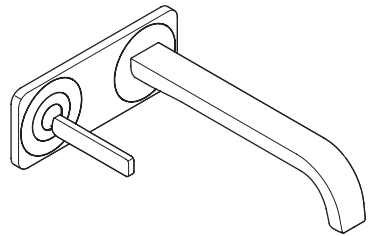
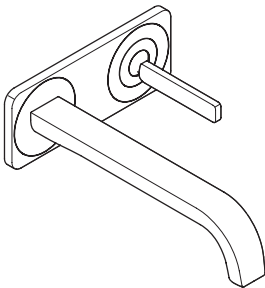
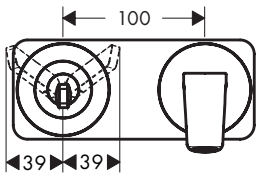
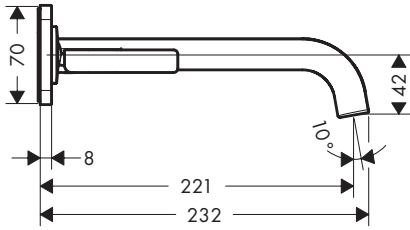



Uno 38815XXX

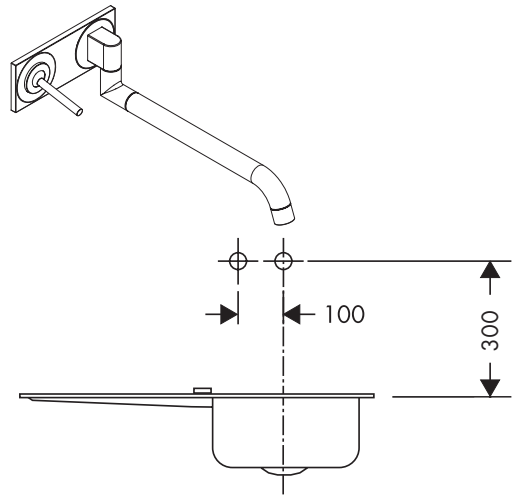
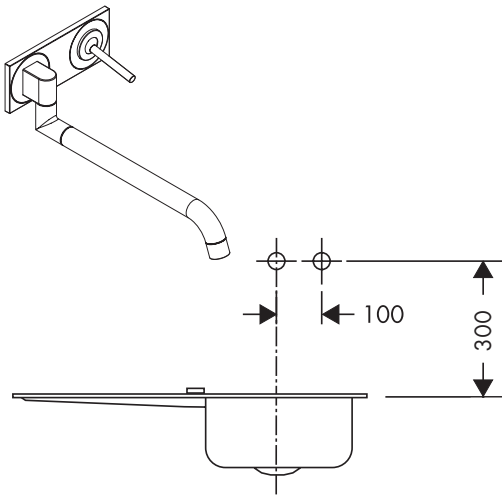
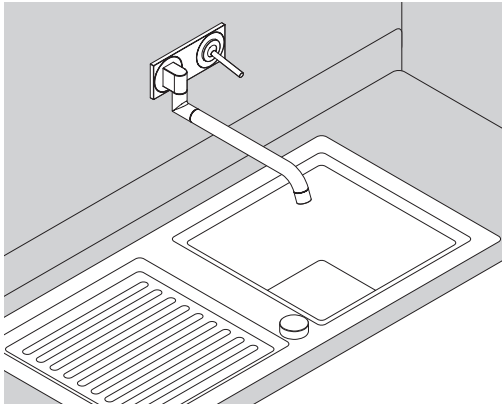
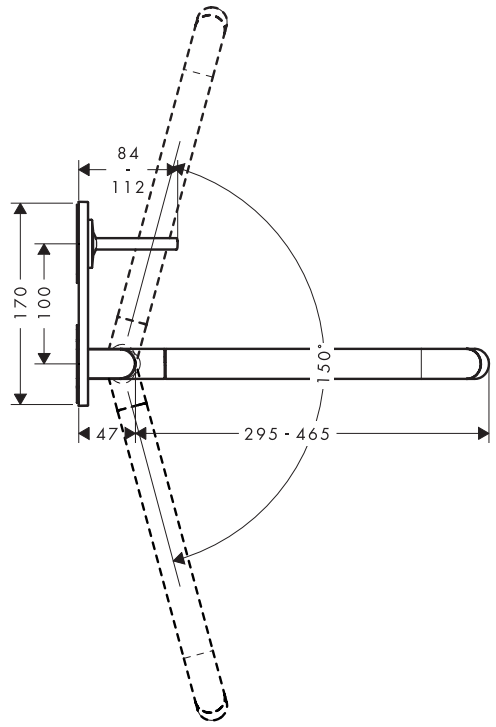
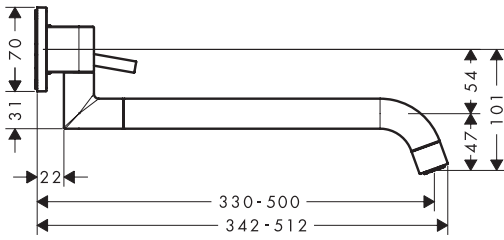



---

**hansgrohe**

Hansgrohe · AuestraÙe 5 · 9 · D-77761 Schiltach · Telefon +49 (0) 78 36/51-1282 · Telefax +49 (0) 7836/511440  
E-Mail: [info@hansgrohe.com](mailto:info@hansgrohe.com) · Internet: [www.hansgrohe.com](http://www.hansgrohe.com)

07/2016  
9.01079.01